

---

# Pinnacle 27/27 EZload Laminator

## INSTALLATION & OPERATION MANUAL

Document Number: CBT10000 Rev B  
Do not duplicate without written permission from ACCO Brands

---



**ACCO Brands reserves the right to make changes to this publication and to the products described in it without notice. All specifications and information concerning products are subject to change without notice. Reference in this publication to information or products protected by copyright or patent does not convey any license under the rights of ACCO Brands or others assumes no liability arising from infringements of patents or any other rights of third parties.**

**This publication is copyrighted © 2016 by ACCO Brands. All rights reserved.**

# 1. Safety

YOUR SAFETY, AS WELL AS THE SAFETY OF OTHERS IS IMPORTANT TO GBC. IN THIS INSTRUCTION MANUAL AND ON THE PRODUCT ARE IMPORTANT SAFETY MESSAGES. BEFORE YOU INSTALL OR USE THE MACHINE, READ AND FOLLOW ALL THE SAFETY NOTICES CAREFULLY IN THIS CHAPTER.

Observe all the safety information provided.  
Observe all safety warnings. Never remove safety warnings or other information from the equipment.

Read all of the instructions and save these instructions for further use.

 **The safety alert symbol precedes each safety notice in this manual. The symbol indicates a potential personal safety hazard to you or others, as well as cause product damage or property damage.**

 **This safety alert symbol indicates a potential electrical shock. It warns you not to open the paper cutter and expose yourself to hazardous voltage.**

THE FOLLOWING WARNINGS ARE FOUND ON THE ULTIMA 65 LAMINATOR.



This means you can be seriously hurt or killed if you open the product and expose yourself to hazardous voltage.

Do not open. No user servicable parts insides. Refer servicing to qualified service personal.



**CAUTION Hot Surface:** Laminator rollers can be in excess of 260° Fahrenheit. Please use caution and do not touch the rollers.



**Caution Moving Parts:** Laminator rollers are moving parts, please keep body parts away from the rollers as they can be trapped and/or crushed in rollers. Clothing, Jewelry, Long hair and other wearables could be caught in roller path and pull you into the



**Caution Sharp Point:** The laminator trimmer has a sharp blade. Do not touch the blade portion of the trimmer and use caution when operating to prevent injury.



**WARNING: Do not attempt to service or repair the laminator.**



**WARNING: do not connect the laminator to an electrical supply or attempt to operate the laminator until you have completely read these instructions. Maintain these instructions in a convenient location for future reference.**

## General safeguards

- Use this laminator only for its intended purposes as according to the specifications outlined in the operating instructions.
- Keep hands, long hair, loose clothing and articles such as necklaces or ties away from the front of the rollers to avoid entanglement and entrapment.
- Avoid contact with the rollers during operation or shortly after the laminator

has been turned off. The rollers can reach temperatures in excess of 300°F.

- Keep hands and fingers away from the path of the sharp film cutter blade located at the film exit.
- Do not place the laminator on an unstable cart, stand or table. An unstable surface may cause the laminator to fall resulting in serious bodily injury. Avoid quick stops, excessive force and uneven floor surfaces when moving the laminator on a cart or stand.
- Do not defeat or remove electrical and mechanical safety equipment such as interlocks, shields and guards.
- Do not insert objects unsuitable for lamination.
- Do not expose laminator to liquids.

### Electrical Safeguards

- The equipment should be connected to an easily accessible and grounded (3-pin) receptacle (socket outlet) near the equipment.
- This laminator must be connected to a supply voltage corresponding to the electrical rating as indicated on the serial plate located on the rear of the machine.
- Unplug the laminator before moving it, or when it is not in use for an extended period of time.
- Do not operate the laminator with a damaged power supply cord or plug.
- Do not overload electrical outlets as this can result in fire or shock.
- Do not alter the attachment plug. This plug is configured for the appropriate electrical supply.
- The unit is intended for indoor use only.



**CAUTION:** The receptacle must be located near the equipment and easily accessible. Do not use an extension cord.

- Disconnect the attachment plug from the receptacle to which it is connected and keep the power supply cord in your possession while moving the laminator.
- Do not operate the laminator with a damaged power supply cord or attachment plug, upon occurrence of a malfunction, or after laminator has been damaged. Contact an authorized GBC service representative for assistance.

### GBC Technical Service

To order replacement accessories, service, parts, or an Equipment Maintenance Agreement, please contact GBC Technical Service and Support at:

#### United States

ACCO Brands GBC Technical Service and Support  
4 Corporate Drive Lake Zurich, IL 60047-8997  
1-800-723-4000  
[www.gbconnect.com](http://www.gbconnect.com)

#### Canada

Ontario and Quebec – 1-800-268-3310  
All other Provinces – 1-800-268-3447  
Local 905-595-3100  
[Callcentre@GBCCanada.com](mailto:Callcentre@GBCCanada.com)

#### Mexico

Circuito de la industria norte  
No. 6 corredor industrial  
Toluca Lerma, Lerma, México  
C.P. 52004 R.F.C. AME640229-1W3  
En México llame al 01 800 759.6825  
Desde el extranjero 52.72.2265.65.01  
[www.accomexico.com](http://www.accomexico.com)

This equipment is not suitable for use in locations where children are likely to be

---

## 2. Warranty

---

### **Limited 1 Year Labor Warranty; USA, Mexico, and Canada**

ACCO Brands USA LLC, ACCO Brands, 4 Corporate Drive, Lake Zurich, IL 60047 (in Mexico, ACCO Brands Mexicana, Neptuno 43, Fraccionamiento Nueva Industrial Vallejo México 07700 D.F. México), (in Canada, ACCO Brands Canada Inc., 7381 Bramalea Road, Mississauga ON L5S1C4) (each, respectively, “ACCO Brands”) warrants to the original purchaser that this ACCO Brands product is free from defects in workmanship and material under normal use and service for a period of: one (1) year for parts and labor after purchase.

ACCO Brands’ obligation under this warranty is limited to replacement or repair, at ACCO Brands’ option, of any warranted part found defective by ACCO Brands without charge for material or labor. Any replacement, at ACCO Brands’ option, may be the same product or a substantially similar product that may contain remanufactured or refurbished parts. This warranty shall be void in the following circumstances:

- (i) if the product has been improperly installed or misused,
- (ii) if the product has been damaged by negligence or accident, or
- (iii) if the product has been altered by anyone other than ACCO Brands or ACCO Brands’ authorized agents.

Without limiting the generality of the previous paragraph, ACCO Brands’ obligation under this limited warranty does not include:

- (iiii) damage caused to the rollers by knives, razors, or other sharp tools; by any foreign objects falling into the working area of the laminator; or by cleaning the laminator with solutions or materials that harm its surfaces;

For warranty execution, please contact ACCO Brands at: 800-723-4000 or [www.gbconnect.com](http://www.gbconnect.com) in the USA 905-595-3100 or [www.gbcanada.com](http://www.gbcanada.com) in Canada (55) 52.72.2265.65.01 or [www.accomexico.com](http://www.accomexico.com) in Mexico

TO THE EXTENT ALLOWED BY APPLICABLE LAW, THIS WARRANTY IS IN LIEU OF ALL OTHER EXPRESSED WARRANTIES. REPRESENTATIONS OR PROMISES INCONSISTENT WITH OR IN ADDITION TO THIS WARRANTY ARE UNAUTHORIZED AND SHALL NOT BE BINDING ON ACCO BRANDS. TO THE EXTENT PERMITTED BY APPLICABLE LAWS, ANY IMPLIED WARRANTIES (IF APPLICABLE) ARE LIMITED IN DURATION TO THE DURATION OF THIS WARRANTY. SOME STATES AND JURISDICTIONS DO NOT ALLOW LIMITATIONS ON HOW LONG AN IMPLIED WARRANTY LASTS, SO THE ABOVE LIMITATION MAY NOT APPLY TO YOU. TO THE EXTENT PERMITTED BY APPLICABLE LAW, IN NO EVENT SHALL ACCO BRANDS BE LIABLE FOR ANY SPECIAL, INCIDENTAL, PUNITIVE, EXEMPLARY, CONSEQUENTIAL OR SIMILAR DAMAGES, WHETHER OR NOT FORESEEABLE. SOME STATES AND JURISDICTIONS DO NOT ALLOW THE EXCLUSION OR LIMITATION OF SPECIAL, INCIDENTAL, PUNITIVE, EXEMPLARY, CONSEQUENTIAL, OR SIMILAR DAMAGES, SO THE ABOVE EXCLUSION OR LIMITATION MAY NOT APPLY TO YOU.

FOR CONSUMERS WHO HAVE THE BENEFIT OF CONSUMER PROTECTION LAWS OR REGULATIONS IN THEIR JURISDICTION OF PURCHASE OR, IF DIFFERENT, IN THEIR JURISDICTION OF RESIDENCE, THE BENEFITS CONFERRED BY THIS WARRANTY ARE IN ADDITION TO ALL RIGHTS AND REMEDIES CONVEYED BY SUCH CONSUMER PROTECTION LAWS AND REGULATIONS.

To the extent permitted by law, this warranty is not transferable and will automatically terminate if the original product purchaser sells or otherwise disposes of the product.

This warranty gives you specific legal rights. Other rights, which vary from jurisdiction to jurisdiction, may exist. In addition some jurisdictions do not allow (i) the exclusion of certain warranties, (ii) limitations on how long an implied warranty lasts and/or (iii) the exclusion or limitation of certain types of costs and/ or damages, so the above limitations may not apply.

### 3. Specifications –

Model	Pinnacle 27	Pinnacle 27EZ
Operating Speed	Variable	Variable
Speed 1 - 10	2 ~ 10 ft./min.	2 ~ 10 ft./min.
Warm-up Time	< 10 Minutes	< 10 Minutes
Maximum Film Width	27"	27"
Maximum Film Roll Diameter	4.25"	4.25"
Film Supplies Supported: <ul style="list-style-type: none"> <li>Film Thickness</li> <li>EZ Load Films</li> <li>Standard 1" Core Films</li> </ul>	Nap I Films <ul style="list-style-type: none"> <li>1.5mil / 3mil (38mic / 75mic)</li> <li>No</li> <li>Yes</li> </ul>	Nap I Films <ul style="list-style-type: none"> <li>1.5mil / 3mil (38mic / 75mic)</li> <li>Yes</li> <li>No</li> </ul>
Dimensions: <ul style="list-style-type: none"> <li>Width</li> <li>Height</li> <li>Depth</li> <li>Weight</li> </ul>	<u>Machine:</u> 35.5" (90.1cm)    41.25" (104.8cm) 12.75" (32.4cm)    18.00" (45.7cm) 19.5" (49.5cm)    26.25" (66.7cm) 111lbs (50.3kgs)    116 lbs. (52.6kgs)	<u>Machine:</u> 35.5" (90.1cm)    41.25" (104.8cm) 12.75" (32.4cm)    18.00" (45.7cm) 19.5" (49.5cm)    26.25" (66.7cm) 111lbs (50.3kgs)    116 lbs. (52.6kgs)
Electrical Requirements <ul style="list-style-type: none"> <li>Voltage</li> <li>Receptacle</li> </ul>	Electrical Requirements <ul style="list-style-type: none"> <li>120V, 60Hz</li> <li>NEMA 5-15R</li> </ul>	Electrical Requirements <ul style="list-style-type: none"> <li>120V, 60Hz</li> <li>NEMA 5-15R</li> </ul>
Environment	Maximum Ambient: 82.4°F (28°C)	Maximum Ambient: 82.4°F (28°C)

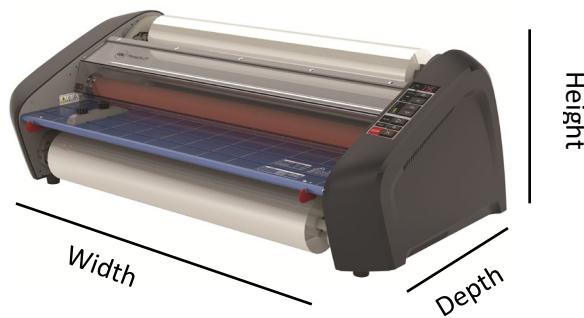

Figure 1: Pinnacle 27/27EZ Dimensions

### **FCC Class B Notice**

This device complies with Part 15 of the FCC Rules. Operation is subject to the following two conditions:

- This device may not cause harmful interference.
- This device must accept any interference received, including interference that may cause undesired operation.

NOTE: This equipment has been tested and found to comply with the limits for a Class B digital device, pursuant to Part 15 of the FCC Rules. These limits are designed to provide reasonable protection against harmful interference in a residential installation. This equipment generates, uses, and can radiate radio frequency energy and, if not installed and used in accordance with the instructions, may cause harmful interference to radio communications. However, there is no guarantee that interference will not occur in a particular installation. If this equipment does cause harmful interference to radio or television reception, which can be determined by turning the equipment off and on, the user is encouraged to try to correct the interference by one or more of the following measures:

- Reorient or relocate the receiving antenna.
- Increase the separation between the equipment and receiver.
- Connect the equipment into an outlet on a circuit different from that to which the receiver is connected.
- Consult the dealer or an experienced radio/TV technician for help.

### **Canada Class B Notice - Avis**

#### **Canada, Class B**

This Class B digital apparatus complies with Canadian ICES-003.

### **Modifications**

Any modifications made to this device that are not approved by ACCO Brands may void the authority granted to the user by the FCC and/or by Industry Canada to operate this equipment.

---

## 4. Installation

---

### Service

 **WARNING:** Do not attempt to service or repair the laminator. Failure to observe this warning could result in severe personal injury or death.

Disconnect the plug from the receptacle and contact GBC Technical Service when one or more of the following has occurred.

- The power supply cord or attachment plug is damaged.
- Liquid has been spilled into the laminator.
- The laminator is malfunctioning after being mishandled.
- The laminator does not operate as described in these instructions.

### Installation

- Shipping damage should be brought to the immediate attention of the delivering carrier.
- Place the laminator on a stable flat surface capable of supporting 150 lbs.
- The surface should be at least 30" high to assure comfortable positioning during operation. All four rubber feet should be on the supporting surface.
- Connect power cord to an appropriate power source. Avoid connecting other equipment to the same branch circuit to which the laminator is connected as this may cause nuisance tripping of the circuit breaker or blown fuses.
- The laminator should be positioned to allow exiting film to drop freely to the floor. Accumulation of laminate as it exits the laminator may cause film to wrap around the rollers, causing a jammed condition.
- Avoid placing laminator near sources of heat or cold. Avoid locating the laminator in the direct path of forced, heated or cooled air.

### Caring for Pinnacle 27/27EZload

The only maintenance required by the operator is to periodically clean the rollers. Keeping the rollers clean ensures that your finished items will not be damaged by dirt and adhesive build-ups.

 **CAUTION:** the following procedure is performed while the laminator is hot. Use extreme caution.

 **WARNING:** Do not apply cleaning fluids or solvents to the rollers.

 **WARNING:** Do not attempt to laminate adhesives marked 'Flammable'.

 **WARNING:** Do not expose laminator to liquids.

1. Remove the film from the laminator following the procedure outlined in the section FILM LOADING AND THREADING.
2. Clean the top and bottom rollers with a clean, damp lint-free cloth. If there are any adhesive build-ups, you may use isopropyl alcohol instead of water.
3. To remove difficult debris Preheat the laminator until the READY LAMP (Green Light) illuminates.
4. Push and hold the SLOW Backward button to rotate the upper and lower rollers with the safety shield open.
5. Follow the procedure in section FILM LOADING AND THREADING, Method Using Film Threading Card to reload the laminator.

**Note:** Do not use metal scouring pads to clean the heat rollers!

**Note:** Covering machine when not in use will reduce dust build-up on the rollers and film which can lead to poor lamination quality.

 **WARNING:** Do not laminate glitter and/or metallic items. Damage to the rollers may result.

The side covers and feed table can be cleaned with a lint-free cloth and a mild detergent.



# 5. Feature Guide

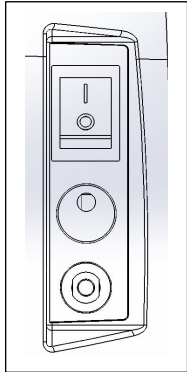

Figure 2

A. **MAIN POWER SWITCH:** Located at the back of the machine, applies power to the laminator. The 'ON' position is indicated by the 'I' symbol. The 'OFF' position marked 'O' symbol (figure 2).

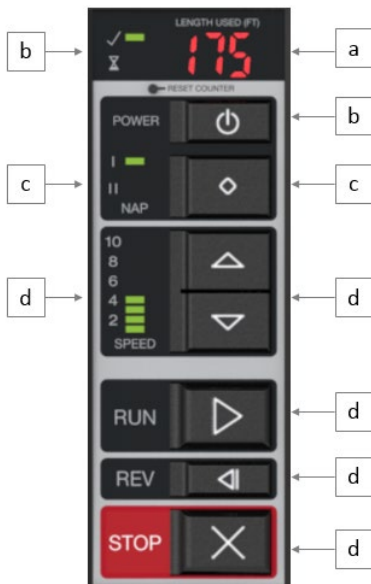

Figure 3

B. **CONTROL PANEL:**

- a. **FOOTAGE COUNTER** – Tracks the number of feet used since last reset. To reset the footage counter press the RESET button.
- b. **ON/OFF BUTTON** – Turns the machine ON/OFF and wake the machine up from standby mode.

- i. **READY** – Machine is ready to use when machine beeps and the LED turns GREEN.
- ii. **WARM-UP** – Machine is warming up when the LED is AMBER and blinking.
- c. **FILM SELECTION** – (NAP I or II) – Press the film selection button to toggle between NAP I and NAP II films.
- d. **SPEED CONTROL** – Controls the speed of the laminator when the run button is pushed.
  - i. **MANUAL SETTINGS 1 THRU 10** – Operator can manually select the speed 1 – 10 by pressing the up or down arrows. The speed will increase as you adjust from 1 to 10.
- e. **RUN** – Push the RUN button to run the laminator in the forward direction.
- f. **SLOW REVERSE** – Press and Hold to run the machine slowly in Reverse. Using SLOW Speed will allow the machine to run even when Heat Shield is open.
- g. **STOP** – Used to stop the laminator.

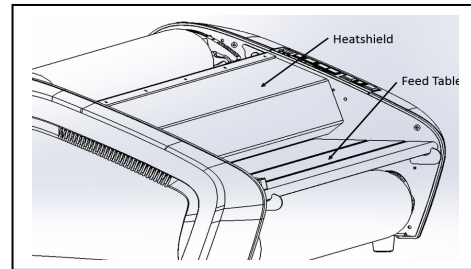

Figure 4

- C. **HEAT SHIELD:** (figure 4) Prevents inadvertent contact with the heat rollers. The HEAT SHIELD must be lowered for the RUN operation to work.
- D. **FEED TABLE:** (figure 4) The Feed Table is used to position items for lamination. Feed table must be installed and latched for laminator to operate.

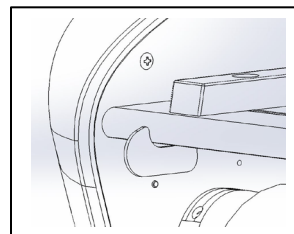

Figure 5

- E. **FEED TABLE LATCHES:** (figure 5) Used to unlock and lock the FEED TABLE.
- F. **FEED TABLE GUIDE:** (figure 5) Aligns items as they are being fed into the laminator. Especially helpful on longer items to reduce skew. The guide can be moved by loosening the knob and sliding the guide

to the desired position and then tightening the knob.

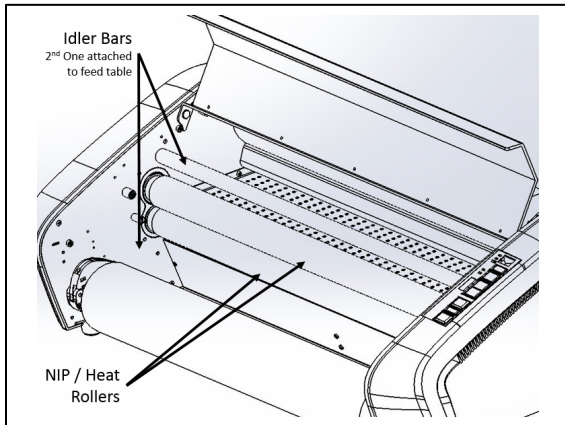

Figure 6

- G. **HEATED NIP ROLLERS:** (figure 6) Heats the film to activate the adhesive and provides pressure to ensure film adheres to the media.
- H. **IDLER BARS:** (figure 6) The Idler Bars, located near each supply roll, are used to direct the film to the NIP ROLLERS. The lower Idler Bar is attached to the Feed Table to facilitate easy film loading.
- I. **PULL ROLLERS:** The Pull Rollers are located at the back of the laminator. They simultaneously pull the film through the laminator and provide tension as the film cools to ensure quality lamination.

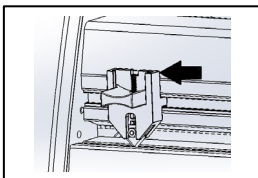

Figure 7

- J. **REAR SLITTER:** (figure 7) Used to cut the film when it exits the rear of the laminator.
- K. **Circuit Breaker:** (figure 2) The circuit breaker is located below the power cord and can be reset by pushing the button. If the circuit continues to fail, please contact authorized service provider.
- L. **AUTO SHUT-OFF:** After two hours of inactivity the laminator will go into Standby mode reducing heat and appearing to be shut down. After three hours of inactivity the machine will shut down. To activate the laminator, ensure the Main Power button is in the ON position ('I') and press the ON/OFF button on the front of the machine.

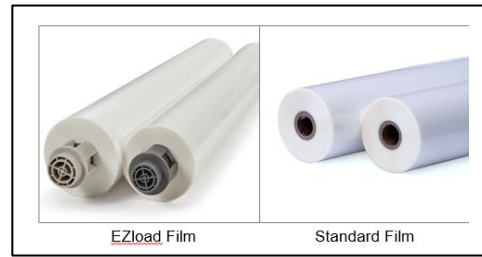

Figure 8

- M. **FILM ROLL SUPPLY:** The Pinnacle 27 uses standard rolls of film while the Pinnacle 27 EZload uses EZ Load laminating film (figure 8).

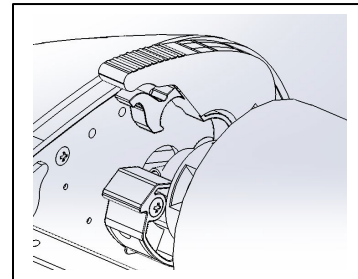

Figure 9

- N. **FILM SADDLES:** EZLoad film supply is loaded into the saddles on the Pinnacle 27EZload (figure 9).

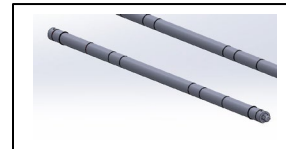

Figure 10

- O. **AutoGrip FILM SHAFT:** The Film Shaft is used for loading standard film onto the Pinnacle 27 Laminator. (Figure 10)

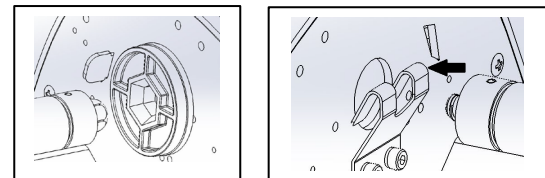

Figure 11

- P. **FILM BRACKET AND HOLDER:** Film shaft is loaded into the holder (figure 10a) and bracket (figure 11b).

# 7. Operation

## FILM LOADING

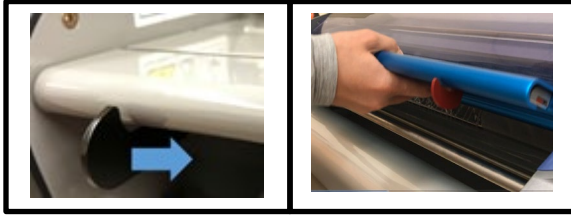

Figure 12

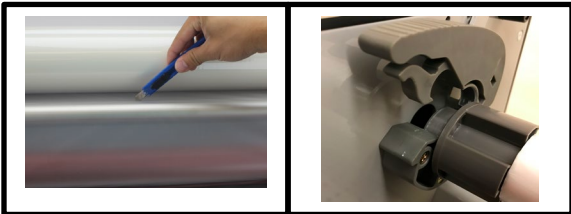

Figure 13

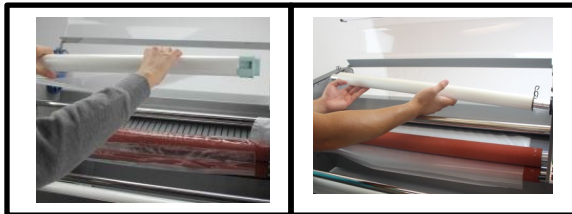

Figure 14



Figure 15



Figure 16

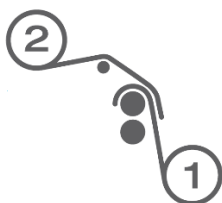

Figure 17

**CAUTION:** the following procedure is performed while the laminator is hot. Use extreme caution.

**TIP:** Film loading is easiest when machine is in a Ready State or while warming up.

**Step 1:** Lift Safety Shield and remove the feed table by pressing inwards on the table latches and lifting up and out. (Fig. 12)

**Step 2:** If reloading film, cut the remaining top and bottom film webs between the supply rolls and the idler bars (Fig 13)

### Pinnacle 27 EZLoad - Film Loading

**Step 3:** Pinnacle EZload Raise the four film levers on the FILM SADDLES and remove the old rolls of film. (Fig. 13)

**Step 4:** Install new film rolls (Fig 14a)

- a. **EZLoad Film** – Insert the film directly into the film saddles, making sure the film end plugs correspond with the saddles in color and size.

**Step 5:** Close the four film holder levers on the saddles. And go to step 6 below.

### Pinnacle 27 - Standard Film Loading

**Step 3:** Remove old rolls of film (Fig. 14b)

- a. Remove Autogrip shafts from machine by lifting up from the film bracket and lightly pulling out of film holder
- b. Slide empty film roll off the shaft away from black O-ring.

**Step 4:** Install new film rolls on film shaft (Fig 14b)

- a. Ensure O-ring on shaft is set in the proper groove based on film width.
- b. Slide the roll of film on the shaft, ensuring film is in proper orientation. Reference Figure 17 for top and bottom roll.

**Step 5:** Re-Install film shaft by first inserting the black hex end of shaft into the Hex Shaft Holder and lowering the other end into the Film shaft bracket.

### Both Models continued

**Step 6:** Thread the film (Reference Fig. 17)

- a. Unwind top and bottom film rolls allowing enough slack for threading.
- b. Drape Lower supply roll (Role 1) over the top idler bar allowing enough slack to close the feed table. (Fig 15a)
- c. Drape the film from Upper roll (2) over the film from the lower roll. (Fig 15b)

- d. Ensure top and bottom film edges are aligned.

**Step 7:** Replace the feed table and close the Heat Shield. Turn the top roll of film an extra ¼ turn to create slack in the film off the top roll. (Fig 16a)

**Step 8:** Using the film threading card included with the film, push the film into the NIP of the Heat Rollers. Continue to push the threading card while the Forward button is hit in step 9. (Fig 16b)

**Step 9:**

Using the RUN button, push until rollers start moving while watching the film thread through the Heat & Pull rollers and observe the film exiting the back of the laminator.

**OPERATION**

1. Move the Main Power switch to the 'ON' ( ) position (figure 1).
2. Ensure the proper film is selected.
3. When the laminator reaches operating temperature, the green ready indicator on the control panel will illuminate.
4. Position the item(s) to be laminated on the feed table.
5. Press the RUN button.
6. Slide the item(s) to be laminated into the Heat Rollers.
7. When the laminated item(s) exit the rear of the laminator, hit the Stop Button.
8. Use the Rear Slitter located at the back of the laminator to separate the laminated item(s) from the film web.
9. During use watch the film exit to ensure film is not drawn back into exit to prevent film wraps.

**Note:** Continuously feeding similar size media in the same location will create a wear spot. Mixing up the feeding location will give heat rollers longer life.

**CLEARING A JAM**

Film jams may occur if the laminator is not positioned to allow exiting film to drop freely to the floor. Accumulation of laminate as it exits the laminator may cause film to wrap around the roller, causing a jammed condition.

To clear a jam it is necessary to rotate the rollers in a reverse direction.

1. Immediately stop the laminator by hitting the Stop Button

2. Open the Heat Shield and remove the Feed Table
3. Cut the top and bottom film webs by the Idler bars
4. Grasp the loose ends of the film web and pull straight out while pushing and holding the Reverse Button.
5. When the film has cleared the Heat Rollers stop the laminator by letting go of the Reverse Button
6. Re-thread the film following the FILM LOADING instructions earlier

**Lamination Speed Guide**

Media Type	Speed	
	Nap I	Nap II
Thin (News Print)	4 – 5	4 – 5
Medium (Copy Paper)	3 – 5	3 – 5
Thick (Card Stock)	2 – 3	2 – 3
Heavy Stock (Poster Board)	1 - 2	1 - 2

**Lamination Tips**

- Do not attempt to laminate abrasive or metal items such as staples or paper clips as they will damage the heat rollers.
- Do not force items into the nip area of the rollers. An item that is not easily drawn into the laminator is probably too thick to laminate.
- Wrinkles may result if an attempt is made to reposition an item once the rollers have grasped it.
- Do not stop the laminator before an item has completely exited the rear of the laminator. Even a momentary stop will cause a mark (heat line) to appear on the laminated item.
- Adhesive will be deposited on the Heat Rollers if:
  - Only one roll of film is used. The top and bottom rolls must be used for problem free lamination.
  - One or both rolls of film are allowed to run completely off the core.
  - Top and bottom roll film edges are not evenly aligned

<b>TROUBLE SHOOTING</b>		
<b>SYMPTON</b>	<b>POSSIBLE CAUSE</b>	<b>CORRECTIVE ACTION</b>
Machine will not turn ON	The Main Power switch on the back is not in the 'ON' ( I ) position.  Laminator is not connected to power source  The Fuse has been blown	Move the main power switch to the 'ON' ( I ) position  Insert plug into appropriate receptacle  Reset the circuit breaker
Machine is ON but will not run	Heat Shield or Feed Table are not fully closed or latched to activate safety switch	Ensure the Heat Shield and Feed table are fully closed.
Machine rollers stop/stall while laminating	Media is too thick  Look for film wrap around rollers	If possible use thinner media.  If film is wrapped around roller use procedure outlined in Clearing a Jam.
Film Doesn't Stick to Media	Machine not hot enough  Running to fast  Wrong Film Setting  Adhesives will not stick to select Inks/Toners/Toner Oils/Coatings	Ensure ready light is on  Try slower speed setting  Confirm proper film thickness selected  If possible print document on another printer
Film or Media appears cloudy, milky or silvering (very small dots typically seen in dark areas)	Machine not hot enough  Running to fast  Wrong Film Setting  Adhesives will not stick to select Inks/Toners/Toner Oils/Coatings  Machine can also be too hot	Ensure ready light is on  Try slower speed setting  Confirm proper film thickness selected  If possible print document on another printer  If above does not resolve try letting the machine cool
Long Ripples appear on the Film and/or Media	Film is too hot when exiting the pull rollers on the back of the machine.	Slow down the laminator  Common on longer lamination runs. Try shorter runs or stop to let cool when present
Waves on one side of the film or media	The film is walking during lamination due to uneven tension	Try swapping the top and bottom film rolls
Waves appear outward from the trailing edge of media (Boat Waking)	Will occur on thicker media	Use thinner media when possible  Slowing down will reduce amount of boat waking
Appearance of small dimples on media and film (Orange Peel)	Machine is too hot	Ensure Ready light is on  Confirm proper film thickness selected  Allow machine to cool
Media and film have little square patterns on the output (Checker boarding)	Film is too hot when exiting the pull rollers on the back of the machine.	Slow down the laminator  Common on longer lamination runs. Try shorter runs or stop to let cool when

		present
Gap/Air Pocket between the edge of the media and the film (Tenting)	Typically found when thicker media is used	Try running slower Ensure ready light is on and proper temperature. When possible use thinner media
Film has bubbles	Uneven tension across the width of the film  Debris in film and/or on the media or roller  Cut or divot in the heat roller silicone	Swap the top and bottom rolls  Wipe them down with a lint-free cloth  Use caution when slitting film for roll changes or jams to prevents cuts into the rollers.
Film curls opposite directions on the edges as it exits the back.	Film supplies not properly matched during manufacturing process	Swap the top and bottom rolls
Media has curl when lamination complete	Film rolls have too much tension or drag on them.  Film Rolls have different amounts of tension	Film rolls should be approximately the same size. Try swapping top and bottom rolls to change the tension.  EZload 27 - Ensure the saddles are fully closed - Clean the saddles with lint-free cloth
Wrinkles in film as the film enters the Heat Rollers	Not enough tension on film rolls	EZload 27 - Ensure the saddles are fully closed - Clean the saddles with lint-free cloth
Excessive Adhesive build up on the Heat Roller edges	The Top and Bottom roller are not aligned.	When using standard film make sure both rolls are pressed up against the film alignment O-ring on the shafts.